

Radio-over-IP Gateway

TRBOnet Swift A200

User Manual

World HQ

Neocom Software
8th Line 29, Vasilyevsky
Island,
St. Petersburg, 199004,
Russia

USA Office

Neocom Software
150 South Pine Island
Rd., Suite 300
Plantation, FL 33324
USA

Sales

EMEA: +44 203 608 0598
Americas: +1 872 222 8726
APAC: +61 28 607 8325

www.trbonet.com

info@trbonet.com

Notices

This document is for informational purposes only. Neocom software, Ltd offers no warranties, express or implied, in this document.

Neocom and the Neocom logo, TRBOnet and the TRBOnet logo are either registered trademarks or trademarks of Neocom software, Ltd.

MOTOROLA, MOTO, MOTOROLA SOLUTIONS and the Stylized M logo are trademarks or registered trademarks of Motorola Trademark Holdings, LLC.

Microsoft, Windows, SQL Server and the .NET logo are either registered trademarks or trademarks of Microsoft Corporation in the United States and/or other jurisdictions.

Other product or company names mentioned herein may be trademarks of their respective owners.

© 2021 by Neocom Software, Ltd. All rights reserved.

This document was last revised on February 8, 2022.

Contents

1	Introduction	3
1.1	About This Document	3
1.2	About TRBOnet Swift.....	3
1.3	Contacts.....	3
2	About TRBOnet Swift A200	4
2.1	Features.....	4
2.2	Capabilities.....	4
2.3	Restrictions	5
2.4	Package Contents.....	5
2.5	Specification.....	5
2.6	Firmware compatibility	6
2.7	Design.....	7
2.8	Connectors.....	8
2.9	OLED Indication.....	9
3	Setup and Connection.....	10
3.1	MOTOTRBO Mode	10
3.2	Non-MOTOTRBO Mode.....	17
3.3	Power Supply	22
4	TRBOnet Configuration.....	24
4.1	TRBOnet Enterprise/PLUS Configuration	25
4.2	TRBOnet Watch Configuration.....	28
5	Maintenance	30
5.1	Built-in Clock Battery Replacement	30
6	Important Notes	31
	Appendix A: Service Cable Examples	32
A.1	Motorola CM 140 Two-Way Radio.....	32
A.2	Motorola SLR 5500 Repeater	33
A.3	Tetra MTM5400/5500 Control Radio.....	34

1 Introduction

1.1 About This Document

The information in this document is intended for engineers responsible for building MOTOTRBO radio networks and programming two-way radios for end users.

The document describes in detail how to connect, set up, and maintain the TRBOnet Swift A200 hardware radio-over-IP gateway.

1.2 About TRBOnet Swift

TRBOnet Swift is a family of hardware products designed by Neocom Software Solutions, Ltd for MOTOTRBO radio networks. The Swift family hardware is presented by the RoIP gateways A100 and A200, and the option board ST002.

For more information about the TRBOnet Swift family products, refer to our [website](#).

1.3 Contacts

Region	Phone	Email & Support
EMEA	+44 203 608 0598	info@trbonet.com — general and commercial inquiries
Americas	+1 872 222 8726	support@trbonet.com — technical support
APAC	+61 28 607 8325	https://trbonet.com/kb/ — online knowledge base

2 About TRBOnet Swift A200

TRBOnet Swift A200 (also referred to as the "A200 gateway") is a hardware radio-over-IP gateway designed to interface your TRBOnet Server to a MOTOTRBO or non-MOTOTRBO control (donor) radio, or a MOTOTRBO repeater in the analog or digital mode.

2.1 Features

- Compact size and light weight
- Support for up to 8 connections with TRBOnet Servers
- Interfaces:
 - 7 I/O contacts for external hardware (SCADA, sensors, and other)
 - USB interface for communication with MOTOTRBO control radios and repeaters
 - Audio interface for communication with non-MOTOTRBO control radios
 - LAN interface for the IP connection (Ethernet 10/100Base-T, 10/100 Mbit/s)
 - Micro-USB port for programming
- 12V DC power supply
- OLED display
- Quick and easy connection and setup

2.2 Capabilities

- A gateway between a radio channel and an IP network

A radio connected to the A200 gateway can transfer voice and data to all connected TRBOnet Servers over IP. The A200 gateway performs no encryption of the transferred voice and data traffic. In addition, the VOX (voice operated transmission) mode is supported on a control radio connected via the A200 gateway.
- Remote control

TRBOnet control room operators can control a connected radio remotely by sending commands (power on/off, channel and zone selection) over IP.
- Self-check and alarm notification

The A200 gateway performs continuous monitoring of all connections and physical parameters (interior temperature, battery status). When an error is detected, the device shows the corresponding information on the display and sends an alarm notification to all connected TRBOnet Servers. The notification is displayed on the screens of TRBOnet control room operators.

2.3 Restrictions

- We do not recommend to install any Swift IP Gateways in the same subnet as trunked repeaters (applies to Capacity Plus and Linked Capacity Plus).

2.4 Package Contents

The package contents of TRBOnet Swift A200 include the following items:

Item	Description	Quantity
TRBOnet Swift A200	A radio-over-IP gateway unit.	1
TRBOnet Swift Transfer ST002	An option board for a MOTOTRBO radio. A flex cable for connecting the option board to the main board of a MOTOTRBO radio.	1
Micro-USB <> USB cable	A programming cable.	1
USB <> RADIO cable	A service cable for connecting a MOTOTRBO radio to the A200 gateway.	1
Audio cable	An audio cable (in and out) for connecting a non-MOTOTRBO two-way radio to the A200 gateway.	1
Micro-Fit connector system	A Micro-Fit plug and a wire kit for connecting the A200 gateway to a non-MOTOTRBO two-way radio, a 12V DC power supply, and external hardware.	1
Screw kit		1
Passport	Technical documentation for TRBOnet Swift Agent A200.	1

2.5 Specification

General	
Dimensions	82 x 34.5 x 102 mm
Weight	200 g
Operation temperature range	-20 °C to +60 °C
Storage temperature range	-40 °C to +85 °C
Ingress protection rating	IP30
Relative humidity, max	85% at +40 °C
Power supply	
Power unput	12 V (+/-15%) DC, 0.5 A max
Display	
	OLED, monochrome, 128 x 32 pix, 0.91 inch
Clock battery	
	3 V, CR1220
Interfaces	
	7 I/O, micro-USB, USB, LAN, UART, Audio In/Out
Network Requirements	
Network connection	RJ45, Ethernet 10/100Base-T, 10/100 Mbit/s

Payload per server connection	160 kbps (PCM/8000) 8 kbps (AMBE)**
Packet delay	< 1800 ms < 3000 ms*
Packet jitter	< 400 ms < 1200 ms*
Packet loss	< 2 %
Number of Server Connections, max	8 1**
Device programming	micro-USB
Radio connection interfaces	
MOTOTRBO	USB (RADIO)
Non-MOTOTRBO	Audio
Inputs/outputs	
Output type	Open collector
Output current, max	100 mA
Input voltage, max	12 V
Audio input	
Nominal level	330 mV RMS
Impedance	10 kOhm
Audio output	
Nominal level	330 mV RMS
Impedance	600 Ohm

- * TRBOnet Swift Agent Firmware Version R04
TRBOnet Enterprise/PLUS of version 5.4 or newer
- ** TRBOnet Swift Agent Firmware Version HL_R04
TRBOnet Enterprise/PLUS of version 5.4 or newer

2.6 Firmware compatibility

Swift Agent Firmware	Connection mode	OB Firmware	Motorola firmware	TRBOnet version	Swift Utilities Pack
A200 USB RoIP Gateway 03.05.04	USB	ST002 USB Transfer for Agent 03.02.10	2020.02	5.6	1.8.2
A200 Analog RoIP Gateway 03.05.00	Analog	N/A	2020.02	5.6	1.8.2
A200 USB RoIP Gateway 03.04.05	USB	ST002 USB Transfer for Agent 03.00.06	2.8	5.2	1.6.1
A200 Analog RoIP Gateway 03.04.05	Analog	N/A	2.8	5.2	1.6.1

2.7 Design

2.7.1 Front Panel

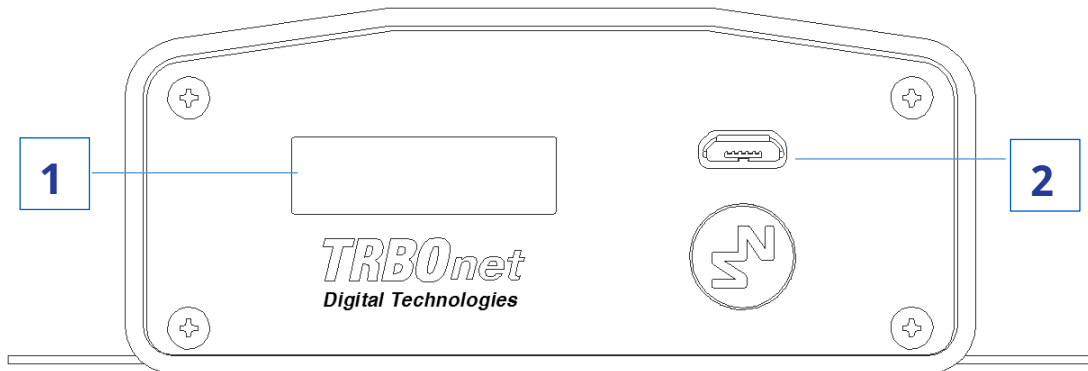

1. OLED display that shows the connection status and self-check information.
2. Micro-USB port to connect the device to a computer using the programming cable.

2.7.2 Rear Panel

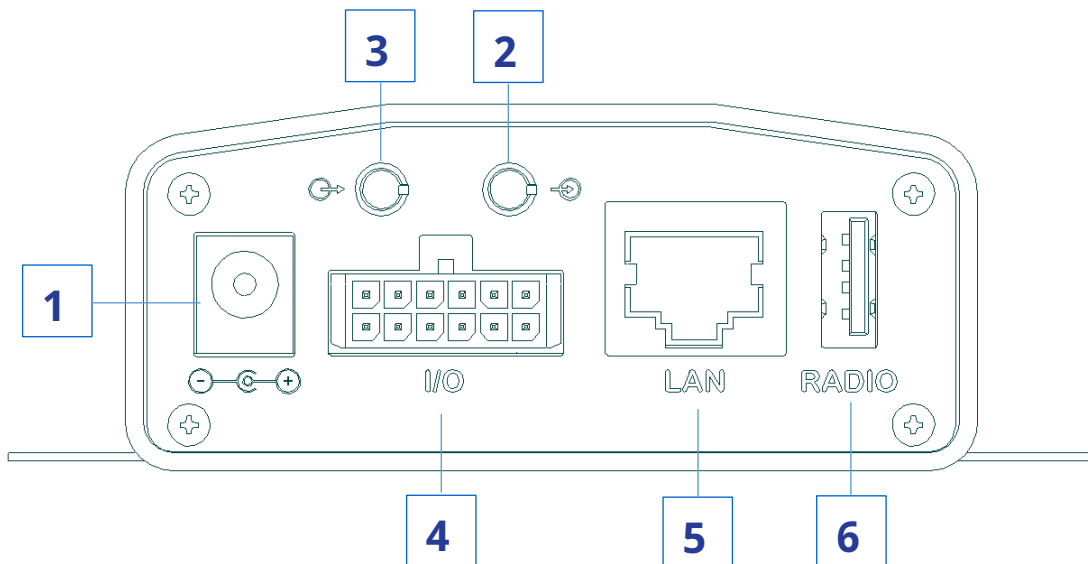





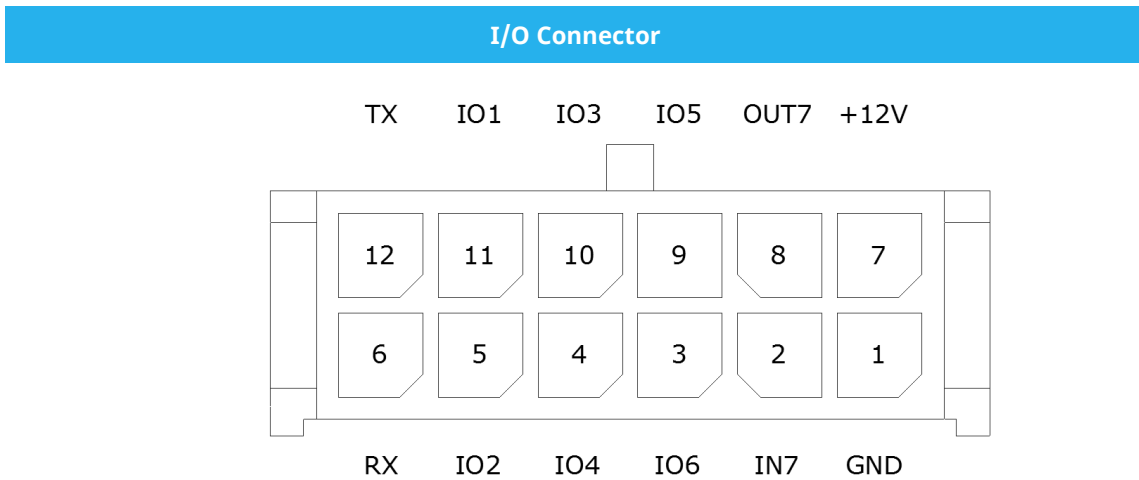



1. DC power inlet.
2. Audio Input to connect a non-MOTOTRBO two-way radio.
3. Audio Output to connect a non-MOTOTRBO two-way radio.
4. Micro-Fit 3mm pitch connector to connect a non-MOTOTRBO radio, a 12V DC power supply, and external hardware.
5. LAN port.
6. USB port to connect a MOTOTRBO radio.

2.8 Connectors



- | | |
|------------------------|--------------------------|
| 1. Power (GND) | 7. Power (+12V) |
| 2. Input (IN7) | 8. Output (OUT7) |
| 3. Input/output (IO6) | 9. Input/output (IO5) |
| 4. Input/output (IO4) | 10. Input/output (IO3) |
| 5. Input/output (IO2) | 11. Input/output (IO1) |
| 6. UART input, 5V (RX) | 12. UART output, 5V (TX) |

2.9 OLED Indication

Icon	State
	<p>Radio connection Flashing icon: The radio is not connected or powered off.</p>
	<p>Radio TX</p>
	<p>Radio RX</p>
	<p>IP connection Digits near the icon: The number of connected TRBOnet servers. Flashing icon: the A200 gateway is not connected to an IP network.</p>
	<p>Activity on the IP connection</p>
	<p>USB connection to the radio</p>
	<p>Low battery charge Flashing icon: Battery replacement is required.</p>
	<p>Built-in clock not set Flashing icon: The built-in clock is not set. Update of the device configuration or battery replacement is required.</p>

3 Setup and Connection

TRBOnet Swift A200 operates in the MOTOTRBO mode or in the non-MOTOTRBO mode. The choice of the operation mode depends on the type of the connected radio.

To configure your A200 gateway, download the Swift Utilities Pack (version 1.6 and higher) from the www.trbonet.com website and install the TRBOnet Swift CPS software tool on your computer.

Then set up and connect your A200 gateway for operation in the preferred mode. Find the details in the following sections:

- [3.1 MOTOTRBO Mode](#) (page 10)
- [3.2 Non-MOTOTRBO Mode](#) (page 17)
- [3.3 Power Supply](#) (page 22)

3.1 MOTOTRBO Mode

To prepare TRBOnet Swift A200 for operation in the MOTOTRBO mode, follow the steps in the table below.

#	Step	Refer to:
1	Update the firmware and configure your A200 gateway.	3.1.1 Configuring the A200 (page 10)
2	Install the option board into the MOTOTRBO radio.	3.1.2 Installing the Option Board (page 13)
3	Update the configuration settings of the radio.	3.1.3 Configuring the Radio (page 15)
4	Update the firmware and configuration settings of the option board.	3.1.4 Configuring the Option Board (page 16)
5	Connect your A200 gateway to the radio and to the LAN.	3.1.5 Connecting the A200 Gateway to the Radio (page 17)
6	Connect your A200 gateway to the power supply.	3.3 Power Supply (page 22)
7	Power up the connected radio.	

3.1.1 Configuring the A200 Gateway

To configure the A200 gateway:

1. Launch TRBOnet Swift CPS. In the main window, select **USB** as an interface for device programming at the bottom left of the window. Connect the programming cable to the micro-USB port of the A200 gateway and to a USB port of your computer.

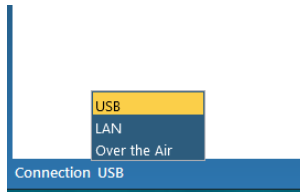

If you prefer to program your A200 gateway using the LAN connection, select **LAN** as the programming interface and connect the A200 gateway to the LAN and to the power supply.

2. (Recommended) Update firmware of your A200 gateway:
 - a. Click **Options** on the **Tools** menu. In the right pane, make sure that the **Allow changing firmware type** option is switched on (see the picture below).

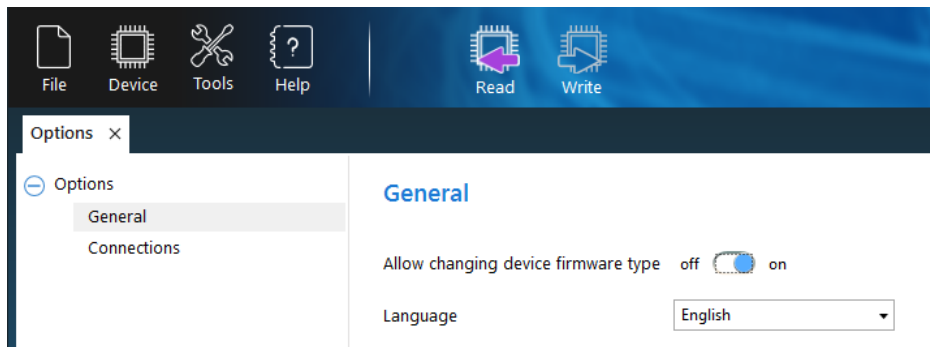

- b. Click the **Read** button, or open the **Device** menu and click **Read**.
 If you use the **LAN** connection for programming, in the **Reading by LAN** window that appears, specify the **Device type** and **IP address** of your A200 gateway, and click **OK**.
 If you use the **USB** connection and the **Select device** window appears, point your device.
 - c. In the left pane, select **Device > Device Information**.
 In the **Device Information** pane, click the **Update Firmware** link.
 - d. In the **Firmware update** window, select your A200 gateway. Open the **Mode** drop-down list and click "USB RoIP Gateway".

Note: If you will connect a TETRA radio to your A200 gateway, select "MTM RoIP Gateway" from the **Mode** list. See also appendix [A.3](#) on page 34.

- e. On the **Update to** menu, select the latest firmware version. Click **Update**.

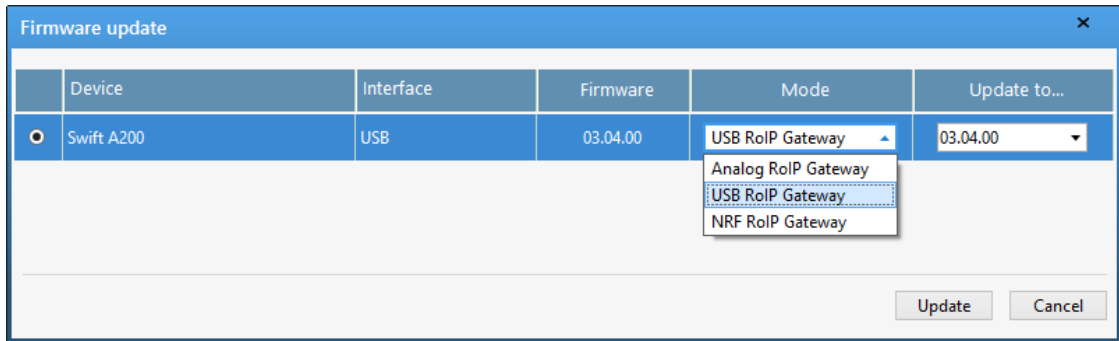

3. To open the configuration of your A200 gateway, click the **Read** button, or open the **Device** menu and click **Read**.
 - If you use the **LAN** connection, the **Reading by LAN** window appears. Specify the **Device type** and **IP Address** of your A200 gateway and click **OK**.
 - If you use the **USB** connection and the **Select device** window appears, point your device.

The configuration settings appear in a separate tab.

4. Click **Network Settings** in the left panel.

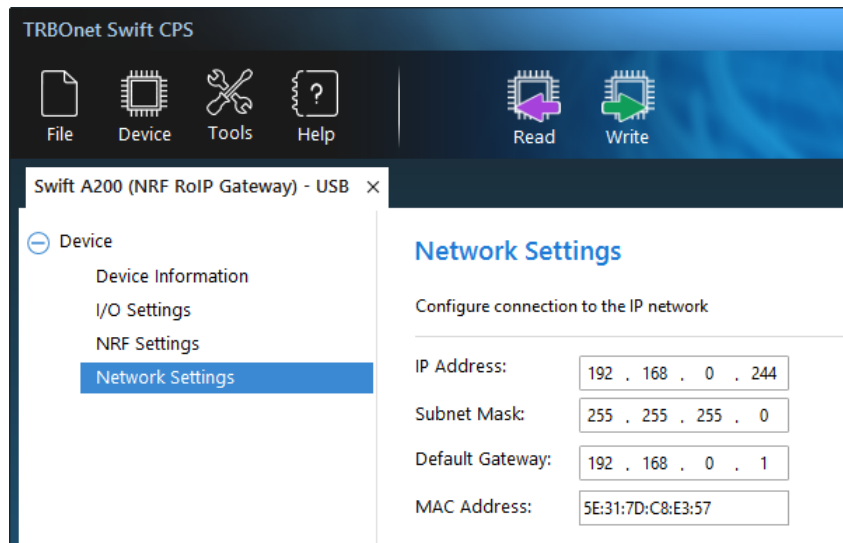

In the right panel, specify the following settings:

- **IP Address:** The IP address assigned to your A200 gateway.
 - **Subnet Mask:** The mask of the subnet to which the A200 gateway belongs.
 - **Default Gateway:** The default gateway of the IP network.
 - **MAC Address:** The default network address of the A200 gateway. Modify it for each A200 gateway to use a unique MAC address on the IP network.
5. (Optional) If you need to display the states of I/O pins in the TRBOnet software tools, click **I/O Settings** in the left panel.

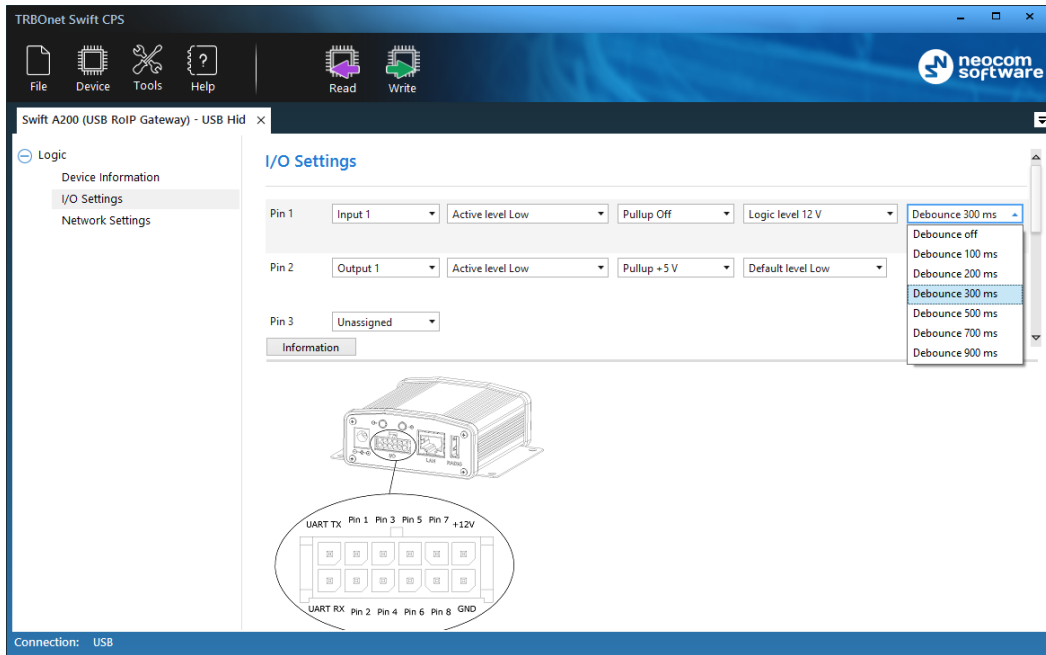

In the right panel, configure the I/O pins of the A200 gateway that are connected to external hardware. For each connected I/O pin, expand the menu, and select the logical pin in TRBOnet:

- For input pins, choose “Input” with the index 1 through 4.
- For output pins, choose “Output” with the index 5 through 10.

Specify the active level of the signal and other I/O pin settings.

Note: For TRBOnet software to display the states of the A200 gateway pins, configure TRBOnet software as described in section [4 TRBOnet Configuration](#) (page 24).

If a physical pin is not connected, leave it unassigned.

6. To save the configuration on your A200 gateway, click the **Write** button or open the **Device** menu and click **Write**.

3.1.2 Installing the Option Board

The delivery kit includes an option board that you need to install into a MOTOTRBO radio.

To install the option board into the radio:

1. Insert the dismantling tool in the groove between the control head and the radio assembly.

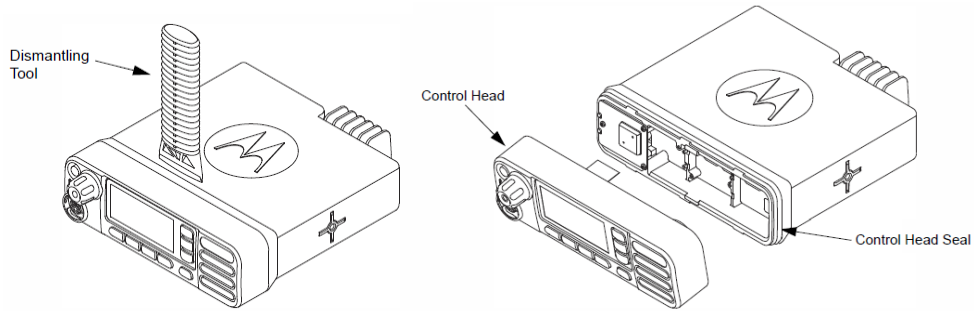

Figure 1: Removing the control head

2. Press the dismantling tool under the control head to release the snap features. Pull the control head away from the radio assembly. Remove the control head seal.
3. Orient the flex cable (supplied in the delivery kit) so that it contacts face the option board. Secure the connector latch to the flex cable.

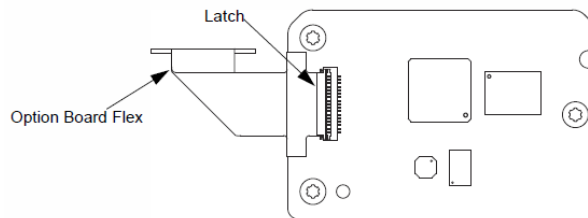

Figure 2: Connecting the flex cable to the option board

4. Connect the flex cable from the option board to the main board connector.

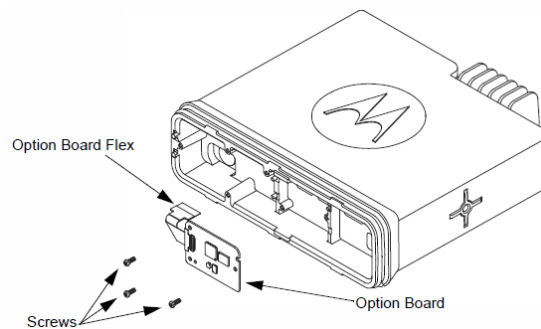

Figure 3: Connecting the option board to the main board of the radio

5. Align the option board to the mounting holes ensuring that the flex tabs are against the chassis alignment posts.
6. Using a T6 TORX™ driver, tighten the three screws to 0.28 N-m (2.5 lbs-in) to secure the option board to the chassis.
7. Assemble the control head seal on the radio. Assemble the control head to the radio chassis by aligning one side of the control head assembly tabs to one side of the radio chassis tabs and then rotate the control head assembly until the other side engages.

Note: Verify that the control head seal is not pinched and not visible. If a pinch is found, disassemble the control head, reseal the seal, and reassemble the control head.

3.1.3 Configuring the Radio

After you have installed the option board into your MOTOTRBO radio, configure the radio using the MOTOTRBO CPS software.

To configure the radio:

1. Power off the radio. Connect the programming cable to the radio and to a USB port of your computer. Power up the radio.
2. Launch the MOTOTRBO CPS software on your computer.
3. Open the configuration settings of your radio by clicking **Read** on the **Device** menu.
4. In the **Set Categories** pane, select **General > General Settings**. In the right pane, uncheck the **Min Speaker Volume Muted** check box.

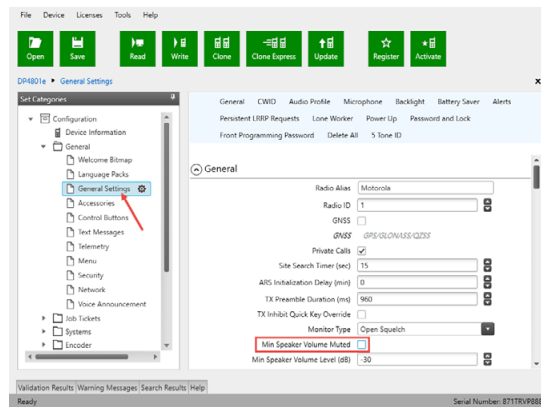

5. In the **Set Categories** pane, select **General > Accessories**. In the right pane, from the **Cable Type** drop-down list, select **Motorola Solutions**.

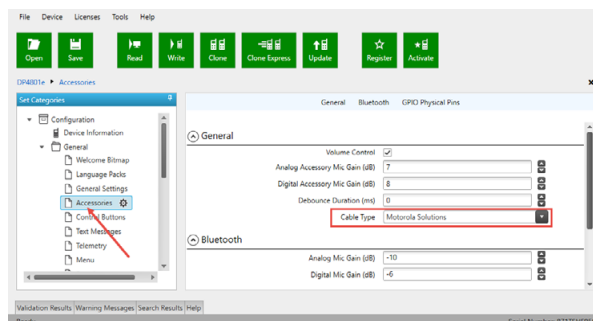

6. In the **Set Categories** pane, select **General > Network**. In the right pane, from the **Forward to PC** drop-down list, select **Via USB**.

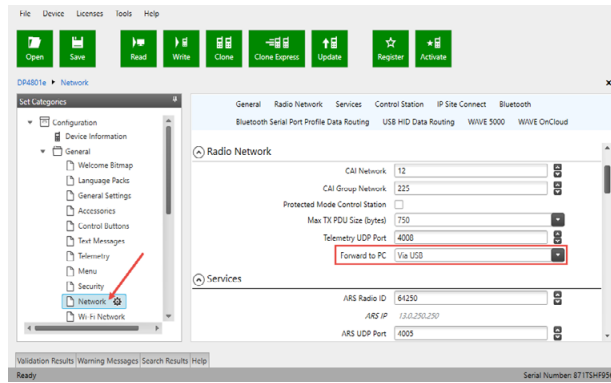

7. In the left pane, expand the **Channels** section. For all channels on which the radio should work with the A200 gateway via the ST002 option board, select **Option Board** in the right pane.

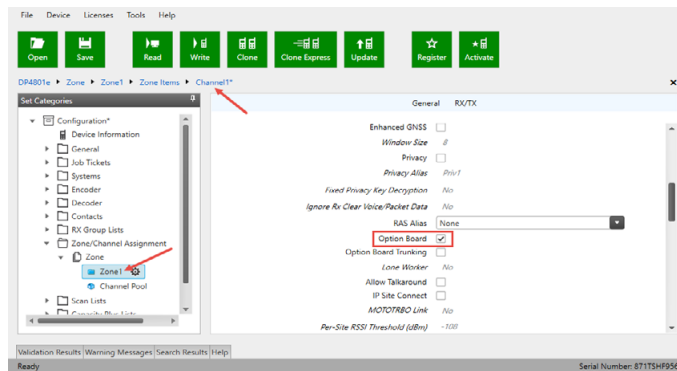

8. Save the updated settings to the radio by clicking **Write** on the **Device** menu.
9. Close the application and disconnect the radio from the computer.

3.1.4 Configuring the Option Board

After you have installed the option board into a MOTOTRBO radio, update the firmware of the option board to the latest version.

To configure the option board:

1. Power off the radio. Connect the programming cable to the radio and to a USB port of your computer. Power up the radio.
2. Launch TRBONet Swift CPS on your computer. In the main window, select **USB** as the programming interface (at the bottom left of the window).
3. Click the **Read** button, or open the **Device** menu and click **Read**.
4. In the left pane, select **Device > Device Information**. In the **Device Information** pane, click the **Update Firmware** link.
5. In the **Firmware Update USB** window, point the option board connected through USB. Expand the **Update to** drop-down menu and select the latest firmware version. Click **Update**.

3.1.5 Connecting the A200 Gateway to the Radio

When all configuration settings are made, connect your A200 gateway to the radio and to the local IP network. The LAN port is located on the rear panel of the A200 gateway.

For the connection between the radio and A200 gateway, use the USB cable supplied with the A200 gateway.

Note: Before connecting the A200 gateway to a MOTOTRBO two-way radio with the USB cable, power off the radio and make sure that the A200 gateway is disconnected from the power supply.

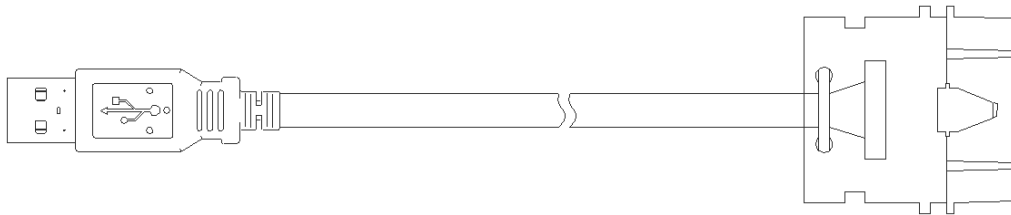

Connect the cable to the USB connector on the rear panel of the A200 gateway and to the rear accessory connector of the radio.

Note: Once you have reconfigured the radio and/or option board, disconnect the programming cable from the radio and reboot by powering off and on both the A200 gateway and the radio.

3.2 Non-MOTOTRBO Mode

To prepare TRBOnet Swift A200 for operation in the non-MOTOTRBO mode, follow the steps in the table below.

#	Step	Refer to:
1	Assemble the service cable.	3.2.1 Assembling the Service Cable (page 18)
2	Update the firmware and configure your A200 gateway.	3.2.2 Configuring the A200 (page 18)
3	Update the configuration settings of the radio.	3.2.3 Configuring the Radio (page 21)
4	Connect your A200 gateway to the radio and to the LAN.	3.2.4 Connecting the Radio (page 21)
5	Connect your A200 gateway to the power supply.	3.3 Power Supply (page 22)
6	Power up the connected radio.	

3.2.1 Assembling the Service Cable

The A200 gateway and a non-MOTOTRBO radio are connected using the service cable and the audio cable. To assemble the service cable, use a Micro-Fit connector plug, a wire kit, and a radio connector plug.

Note: The radio connector plug is not included in the delivery kit. Contact the manufacturer of your radio or a sales representative to get the plug compatible with the service connector of your radio.

To assemble the service cable:

1. Connect the wires to the Micro-Fit plug and to the radio connector plug to implement the following required links:

Function	Micro-Fit plug	Radio connector plug
PTT	Any output pin (Pin 1 – Pin 7)	Use pins as advised in the documentation of the radio.
CSQ Detect	Any input pin (Pin 1 – Pin 6, Pin 8)	
Ground	GND pin (black wire)	

Note: The Micro-Fit connector pins are described in section [2.8 Connectors](#) (page 8).

2. Connect the wires of the audio cable (provided in the delivery kit) to the radio connector plug. Implement the following required links:

Audio cable (wires)	Radio connector pin (function)
Audio In	RX AUDIO
Audio Out	EXT MIC AUDIO (TX AUDIO)
Ground	AUDIO GND

3. (Optional) Add wires between the Micro-Fit plug and the radio connector plug to implement additional features. Consult the documentation of your radio to learn about supported GPIO pin functions.
4. (Optional) Connect external hardware (sensors, controllers) to the I/O pins of the Micro-Fit plug.

For examples, see [Appendix A: Service Cable Examples](#).

3.2.2 Configuring the A200 Gateway

To configure the A200 gateway:

1. Launch TRBOnet Swift CPS. In the main window, select **USB** as an interface for device programming at the bottom left of the window. Connect the programming cable to the micro-USB port of Swift A200 and to a USB port of your computer.

If you prefer to program your A200 gateway using the LAN connection, select **LAN** as the programming interface and connect the A200 gateway to the LAN and to the power supply.

2. (Recommended) Update the firmware of your A200 gateway:
 - a. Click **Options** on the **Tools** menu. In the right pane, make sure that the **Allow changing device firmware type** option is switched on.

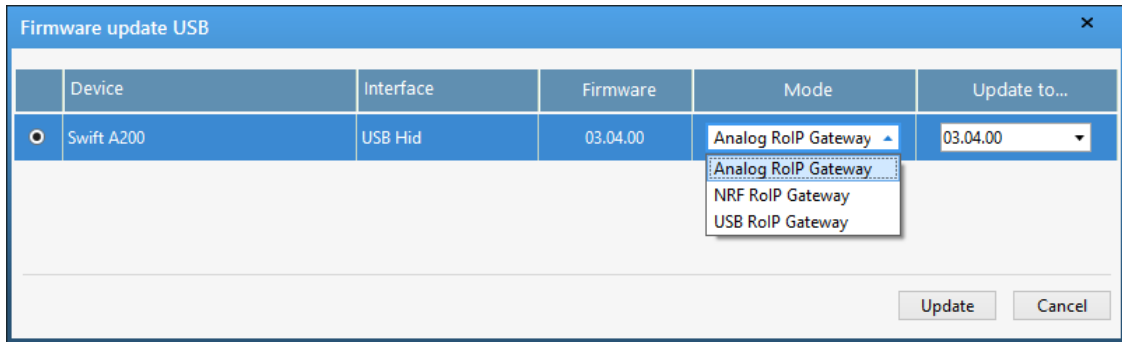

- b. Click the **Read** button, or open the **Device** menu and click **Read**.
If you use the **LAN** connection for programming, in the **Reading by LAN** window that appears, specify the **Device type** and **IP address** of your A200 gateway, and click **OK**.
If you use the **USB** connection and the **Select device** window appears, point your device.
 - c. In the left pane, select **Device > Device Information**.
In the Device Information pane, click the **Update Firmware** link.
 - d. In the **Firmware update** window, select your A200 gateway. Open the **Mode** drop-down list and click "Analog RoIP Gateway".

Note: If you will connect a TETRA radio to your A200 gateway, select "MTM RoIP Gateway" from the **Mode** list. See also appendix [A.3](#) on page 34.

- e. On the **Update to** menu, select the latest firmware version. Click **Update**.
3. To open the configuration of your A200 gateway, click the **Read** button, or open the **Device** menu and click **Read**.
 - If you use the **LAN** connection, the **Reading by LAN** window appears. Specify the **Device type** and **IP Address** of your A200 gateway and click **OK**.
 - If you use the **USB** connection and the **Select device** window appears, point your device.

The configuration settings appear on a separate tab.

4. Click **Network Settings** in the left panel. Specify the following settings:
 - **IP Address:** The IP address assigned to your A200 gateway.

- **Subnet Mask:** The mask of the subnet to which the A200 gateway belongs.
- **Default Gateway:** The default gateway of the IP network.
- **MAC Address:** The MAC address of your A200 gateway.

5. Click **I/O Settings** in the left panel. In the right panel, configure the I/O connector pins:

- For I/O pins connected to the service cable, specify the function (PTT Output, CSQ Input, other), the active level, and other I/O pin settings.

Note: The coupled pins of the radio connector must be configured to use the matching function and active level. For details, refer to section [3.2.3 Configuring the Radio](#) (page 21).

- If any I/O pins are connected by external hardware, configure the A200 gateway to send the states of these pins to TRBOnet software. For each I/O pin connected by external hardware, expand the menu and select the logical pin in TRBOnet:
 - For input pins, choose “Input” with the index 1 through 4.
 - For output pins, choose “Output” with the index 5 through 10.

Specify the active level of the signal and other I/O pin settings.

Notes: For TRBOnet software to display the pin states received from the A200 gateway, configure TRBOnet software as described in section [4 TRBOnet Configuration](#) (page 24).

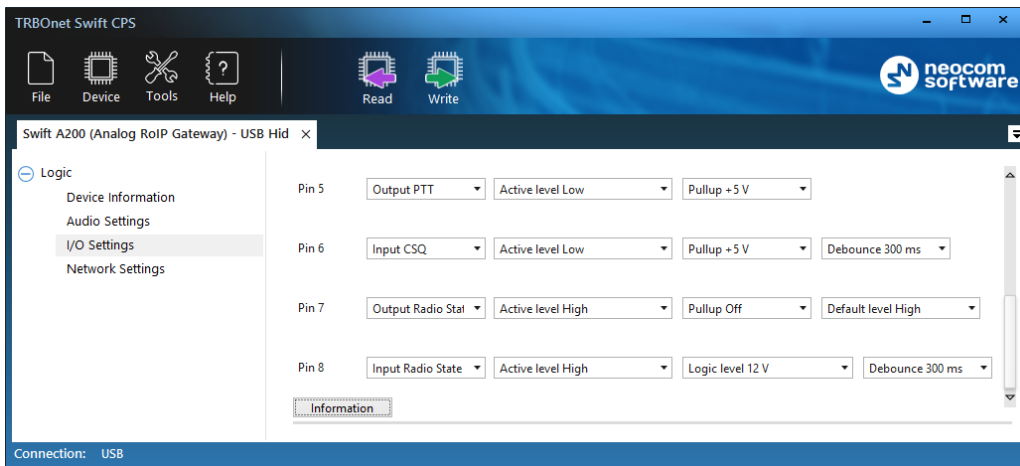

Note: For the VOX (voice operated transmission) mode to work, the **Input CSQ** value must not be selected for any pin.

6. Click **Audio Settings** in the left panel. In the right panel, do the following:
- Use the sliders to adjust the level of the input (incoming to A200 gateway) and output (outgoing from A200 gateway) audio signals in the range of -42Db to 20 Db.

- To raise the level of the input audio signal, adjust the amplifier by selecting the appropriate gain factor from the drop-down list (6, 12, 24).
- To lower the level of the input signal from a non-MOTOTRBO radio, consider setting **Input for Audio** to **IN2**.

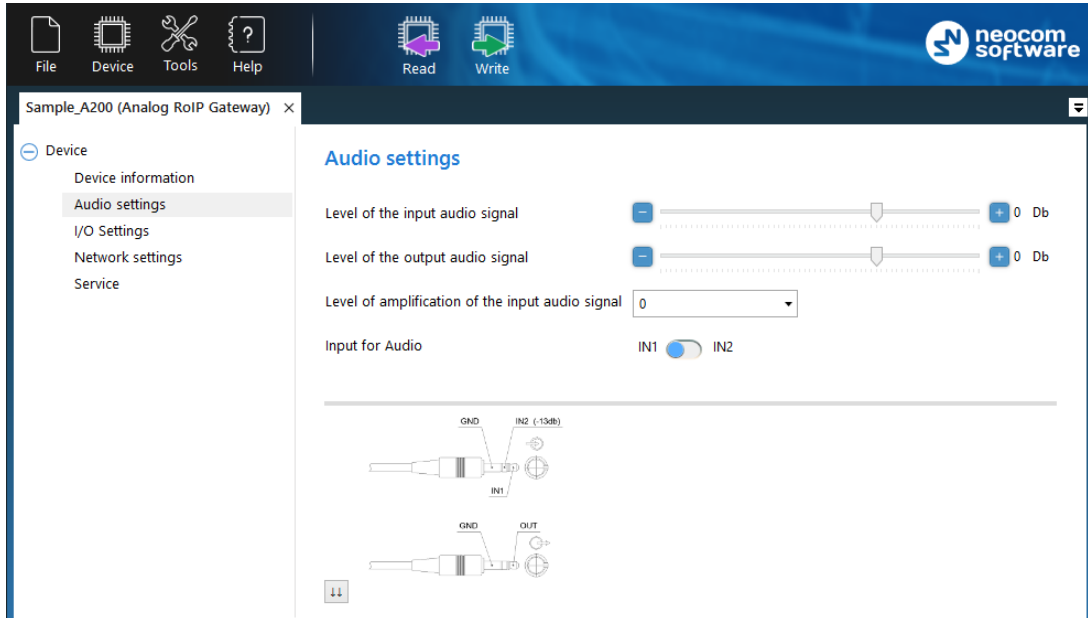

7. To save the configuration to your A200 gateway, click the **Write** button, or open the **Device** menu and click **Write**.

3.2.3 Configuring the Radio

After you have assembled the service cable, configure your radio to use the radio connector pins that are coupled with the pins of the A200 gateway. Use the radio programming software provided by the manufacturer of the radio.

Program the GPIO pins of your radio as described in the documentation supplied by the manufacturer of the radio.

3.2.4 Connecting the Radio

When the service cable is finished and pins are configured on the radio and on the A200 gateway accordingly, connect your A200 gateway to the radio and to external hardware (if necessary).

Note: Before connecting the A200 gateway, make sure that the radio is powered off and that the A200 gateway and all external hardware (if any to be connected) is disconnected from the power supply.

To connect the A200 gateway to the radio and to external hardware:

1. Connect the Micro-Fit plug of the service cable to the Micro-Fit connector on the rear panel of the A200 gateway.

2. Connect the audio cable to the audio input and audio output on the rear panel of the A200 gateway.
3. Connect the other end of the service cable to the service jack of the radio.
4. If required, connect the wires of the service cable to external hardware.

When all connections are done, connect the A200 gateway and external hardware to the power supply. Then power up the radio.

3.3 Power Supply

This section describes how to connect the A200 gateway to the source of +12V DC (recommended) or to an AC power supply.

3.3.1 DC Power Supply

To power the A200 gateway from a DC power source, use the Micro-Fit connector supplied in the delivery kit. The Micro-Fit plug and the wires are connected as follows: the red wire links contact 2 (+12V) and the black wire links contact 1 (GND).

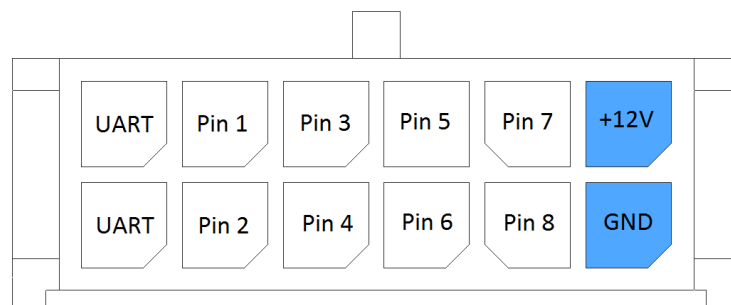

To connect your A200 gateway to a DC power source:

1. Insert the Micro-Fit plug into the I/O jack on the rear panel of the A200 gateway.
2. Connect the other end of the red wire to terminal (+) and the black wire to terminal (-) of a DC power unit.

3.3.2 AC Power Supply

The AC power cable is not supplied with the A200 gateway. To power the A200 gateway from an external AC power source, use any power cable with the 5.5mm x 2.5mm DC plug and the AC/DC adaptor with the DC output of +12V (positive polarity) and the input AC voltage recommended for your region. Find all information on the label of the power adaptor.

Note: Before connecting the A200 gateway to an AC power supply, test the power adaptor to make sure it has the proper voltage and polarity. The use of a power adapter with reverse polarity or higher voltage may cause damage to the A200 gateway.

To connect your A200 gateway to an AC power source:

1. Connect the power cable through the AC/DC adaptor to the AC power inlet located on the rear panel of your A200 gateway.
2. Plug the power cable into an AC power source.

4 TRBOnet Configuration

This section describes how to configure TRBOnet software so that the operator could see and manage the physical I/O pins of the A200 gateway. In the example below, the A200 gateway is connected to a MOTOTRBO radio through USB and has three input pins and two output pins connected to external hardware (see the picture below).

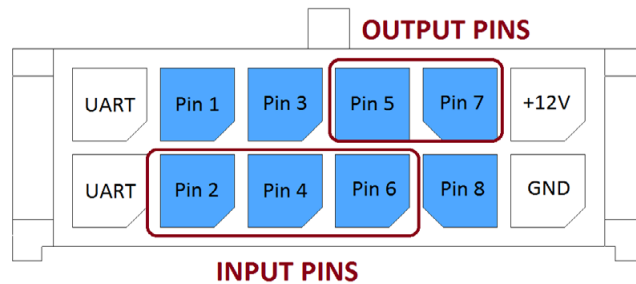

In the A200 gateway configuration, the physical I/O pins are mapped to the logical pins of TRBOnet (see the screenshot below).

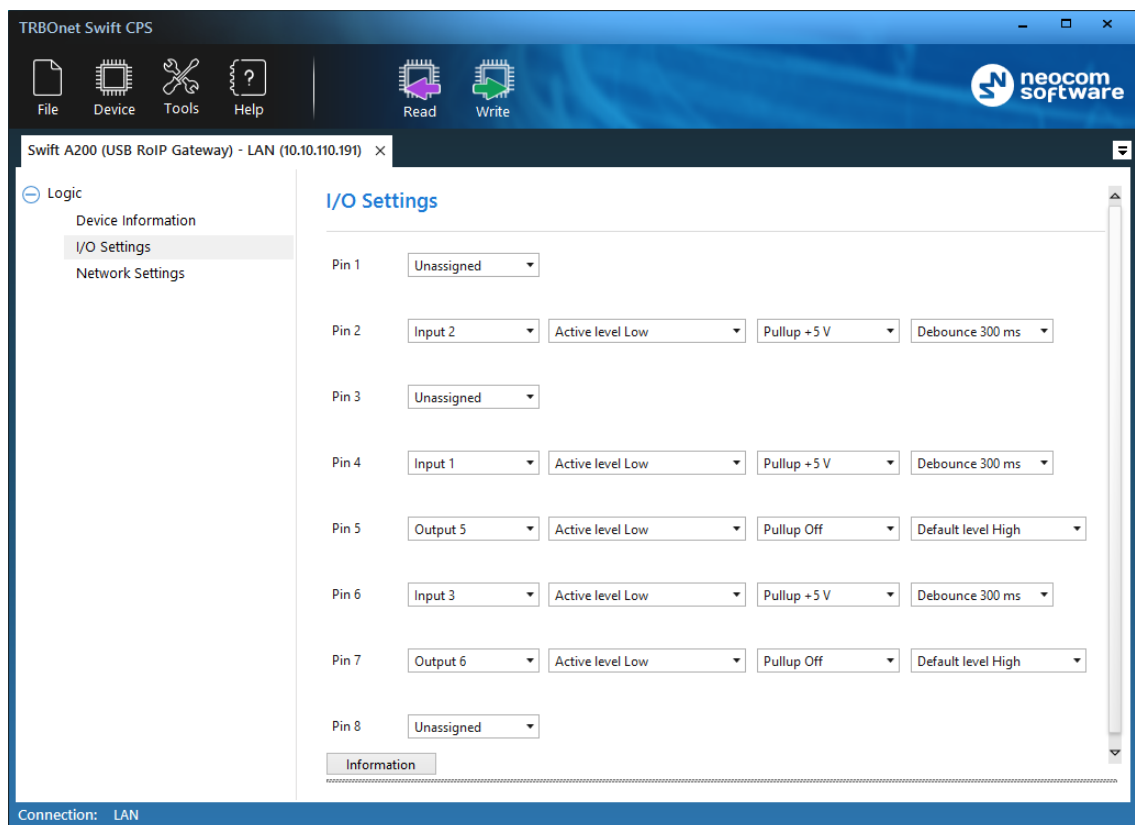

To complete the I/O pin configuration in TRBOnet, read the following sections:

- [4.1 TRBOnet Enterprise/PLUS Configuration](#) (page 25)
- [4.2 TRBOnet Watch Configuration](#) (page 28)

4.1 TRBOnet Enterprise/PLUS Configuration

I/O pins of the A200 gateway are supported in TRBOnet Enterprise (PLUS) 4.8.1.1008 and later versions. In this example, the A200 gateway is registered as a radio system in the TRBOnet Enterprise (PLUS) Server configuration (see the screenshot below).

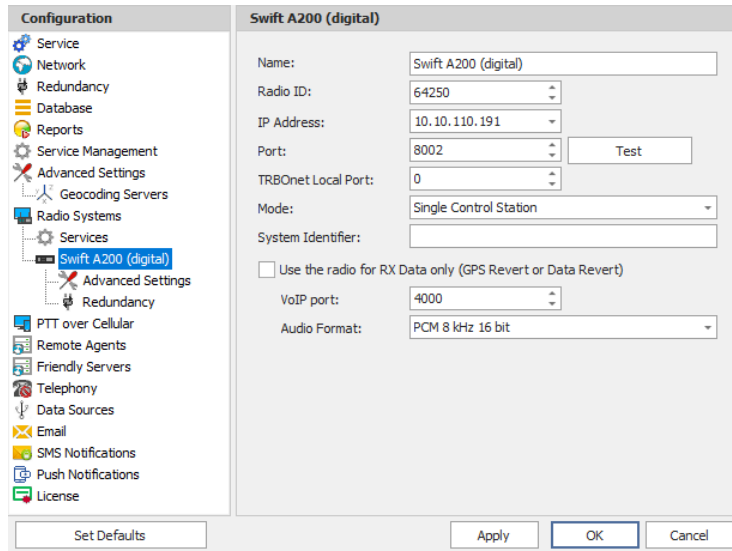

Launch the TRBOnet Dispatch Console and click **Voice Dispatch** in the left pane. If registered correctly, your A200 gateway appears on the **Radio Interface** tab with the green (“connected”) icon (see the screenshot below).

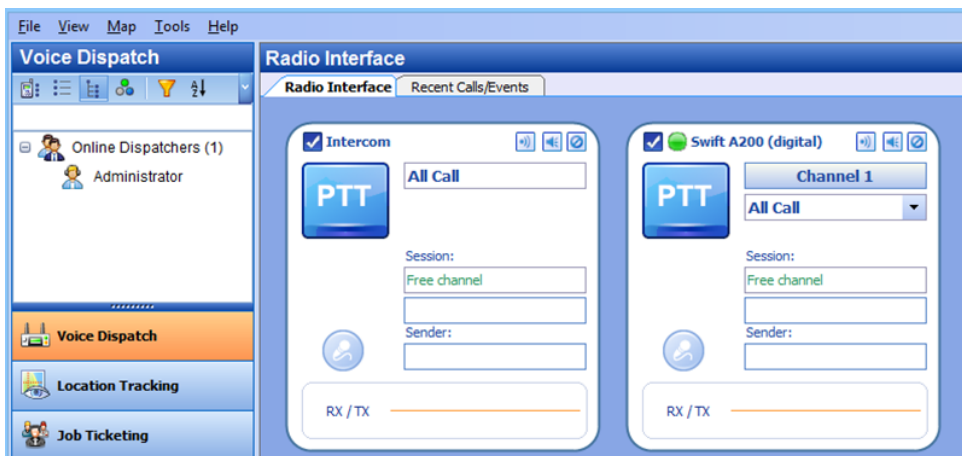

To configure pins:

1. In the TRBOnet Dispatch console, click **Administration** and **Radio Systems** in the left pane (see screenshot below, step 1 and 2).
2. In the right pane, the list of the registered radio systems appears. Double-click the radio system associated with your A200 gateway (see screenshot below, step 3).

3. In the popup window, click the **Channels** tab. Double-click the channel (see screenshot below, step 4), or select it and click **Properties**. Another popup window appears.
4. In the second popup window, click the **Master Control** tab and configure pins.

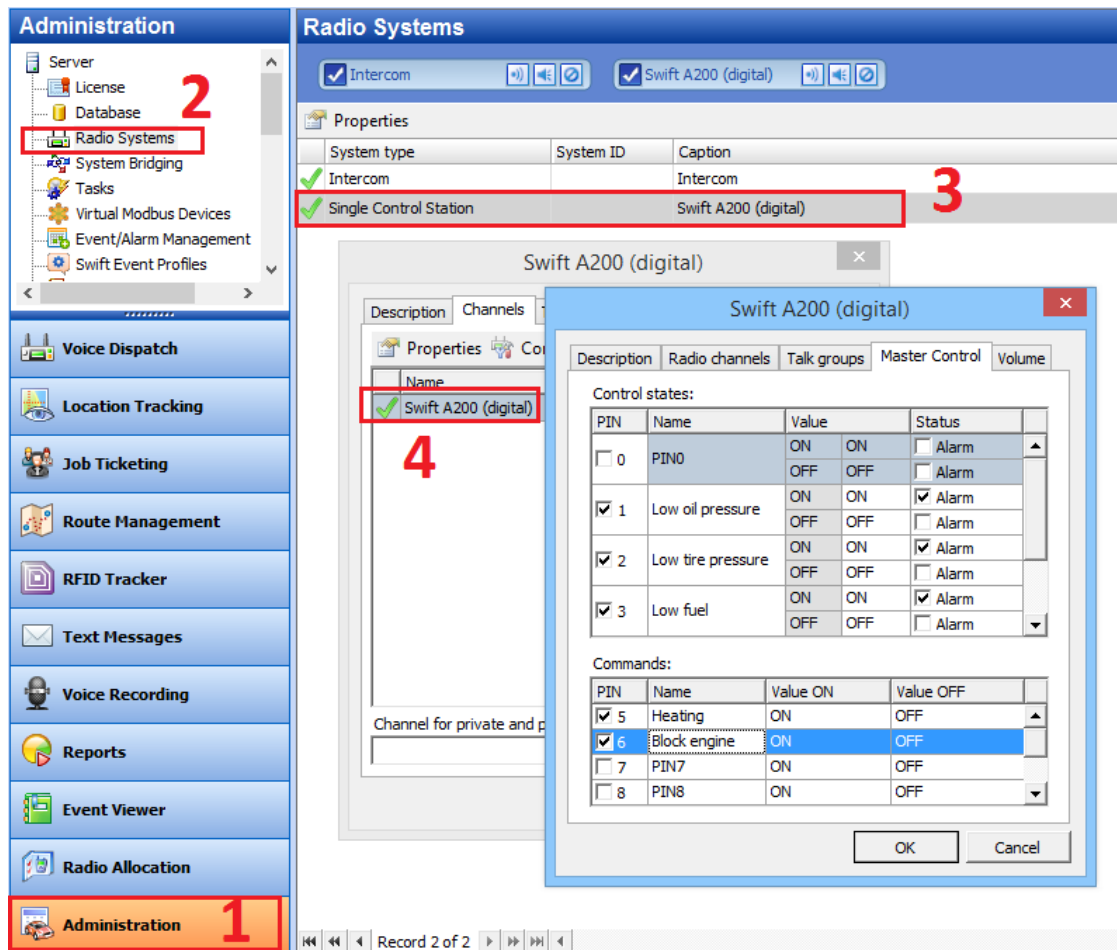

The screenshot displays the Neocom software interface for configuring a radio system. The left sidebar shows the 'Administration' menu highlighted with a red box and the number '1'. The 'Radio Systems' section at the top shows 'Intercom' and 'Swift A200 (digital)' selected, with 'Swift A200 (digital)' highlighted with a red box and the number '3'. A 'Swift A200 (digital)' popup window is open, showing the 'Channels' tab with 'Swift A200 (digital)' selected and highlighted with a red box and the number '4'. A second 'Swift A200 (digital)' popup window is open, showing the 'Master Control' tab. This window contains two tables: 'Control states' and 'Commands'.

PIN	Name	Value	Status
<input type="checkbox"/> 0	PIN0	ON OFF	<input type="checkbox"/> Alarm
<input checked="" type="checkbox"/> 1	Low oil pressure	ON OFF	<input checked="" type="checkbox"/> Alarm
<input checked="" type="checkbox"/> 2	Low tire pressure	ON OFF	<input checked="" type="checkbox"/> Alarm
<input checked="" type="checkbox"/> 3	Low fuel	ON OFF	<input checked="" type="checkbox"/> Alarm

PIN	Name	Value ON	Value OFF
<input checked="" type="checkbox"/> 5	Heating	ON	OFF
<input checked="" type="checkbox"/> 6	Block engine	ON	OFF
<input type="checkbox"/> 7	PIN7	ON	OFF
<input type="checkbox"/> 8	PIN8	ON	OFF

- Under **Control states**, select the logical input pins that you have mapped in the configuration of your A200 gateway. Do not select pin 0. For each selected pin:
 - Double-click the value in the **Name** field and enter a descriptive pin name.
 - In the **Value** field, you see the pin states (ON and OFF) and their displayed values (also ON and OFF by default). If necessary, double-click the value in the second column and enter a custom name of the pin state.
 - In the **Status** field, select **Alarm** for the TRBOnet Dispatch Console operator to see an alarm box when the given pin state is detected.
- Under **Commands**, select the logical output pins that you mapped to the physical pins of your A200 gateway. For each selected pin, specify a

descriptive name. In the **Value ON** and **Value OFF** fields, double-click the value and enter a custom name of the command.

5. Click **OK** and again **OK**.

To see the configured pins, click **Voice Dispatch** in the left pane. Click the green icon in the PTT box of your A200 gateway (see the screenshot below).



The pin states will appear in the window that opens:

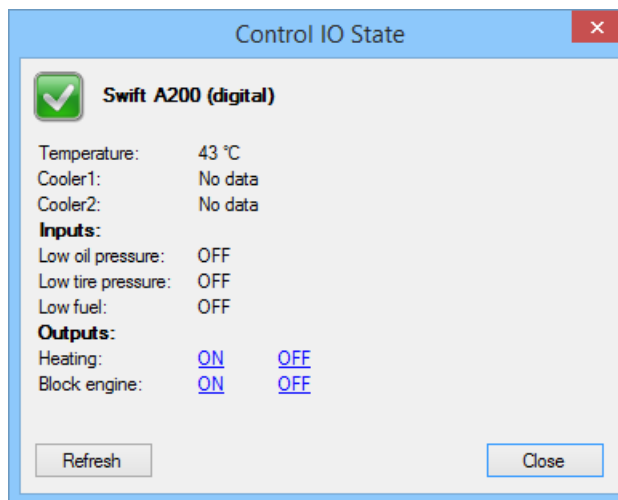

The temperature is measured inside the unit and transmitted to TRBOnet by default, no additional configuration is required. The coolers are missing (“No data”).

Input and output pins appear with their custom names. The input pin states are read-only. The operator can change the output pin states by clicking a respective command next to the pin name (**ON** and **OFF** under **Outputs** in the screenshot above). Or, the operator can right-click the green icon in the PTT box of the A200

gateway and change the output pin states from the popup menu (see the screenshot below).

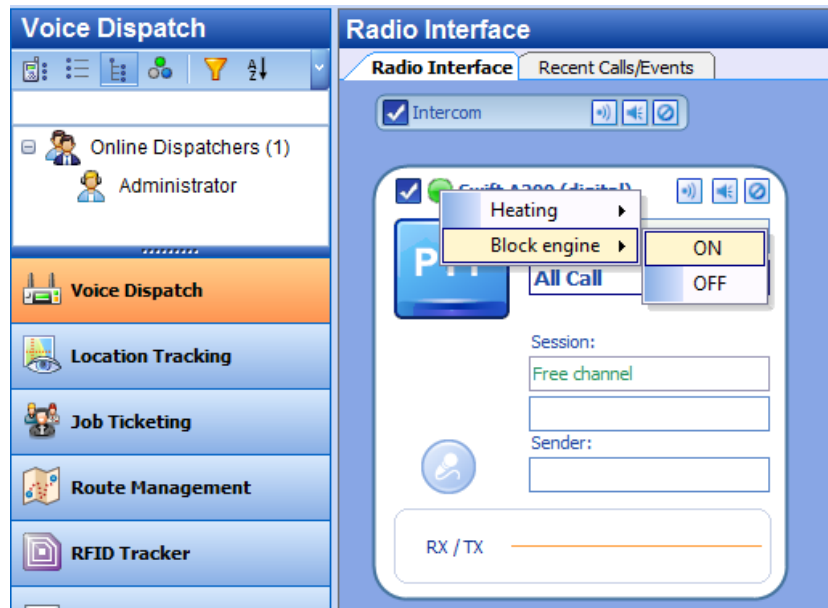

4.2 TRBOnet Watch Configuration

I/O pins of the A200 gateway are supported in TRBOnet Watch 2.5 and later versions. In this example, the A200 gateway is registered as a radio system in the TRBOnet Watch server configuration (see the screenshot below).

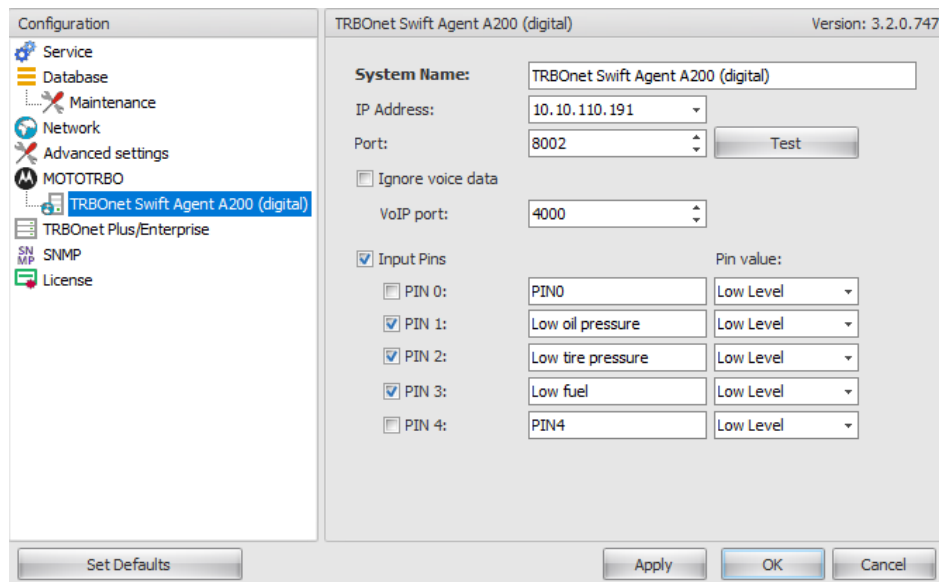

Enable the **Input Pins** feature and configure pins as follows:

- Select the logical input pins (**PIN 1** through **PIN 4**) that you have mapped in the configuration of your A200 gateway. Leave **PIN 0** not selected.
- If needed, enter a descriptive name for each input pin. Otherwise, the console will display the default pin names (PIN1, PIN2, and so on).

- For each pin, expand the **Pin value** menu and select the active level exactly as specified in the A200 gateway configuration.

After you apply the changes, launch the TRBOnet Watch console and click **Live Monitor** in the left pane. You can see the states of the connected A200 gateway pins on the **Diagnostics** tab and on the **Physical GPIO Pins** tab.

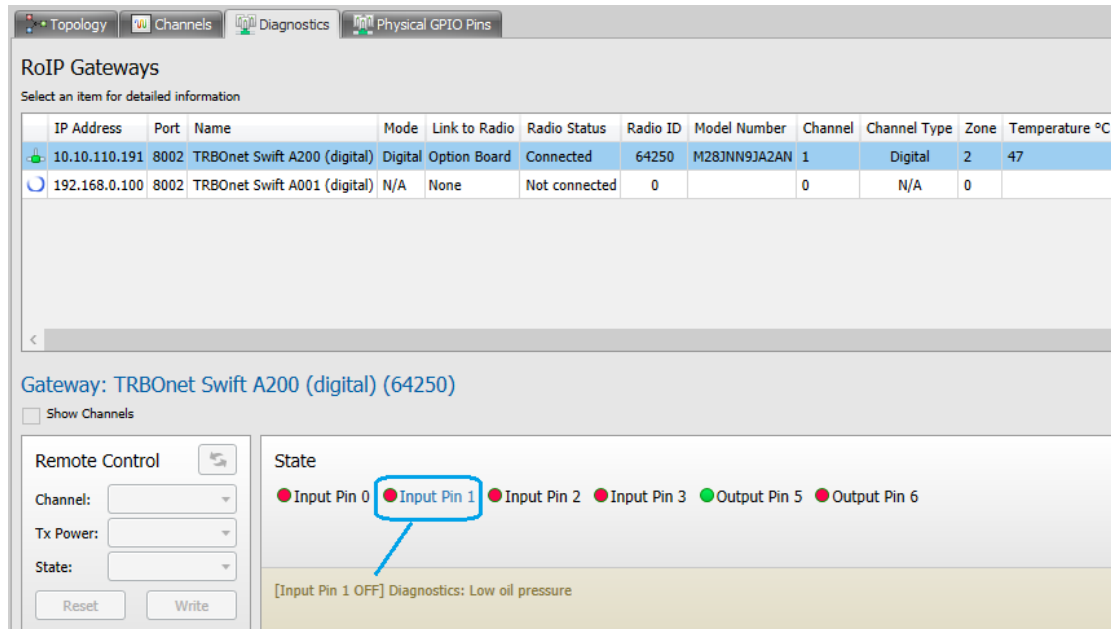

The **State** panel shows all pins (input and output) that are connected to external hardware.

- The green icon indicates the active level on the pin.
- The red icon indicates an inactive pin.

Point the mouse cursor at the pin in the **State** panel to see the detailed information about the pin (see the screenshot above).

5 Maintenance

5.1 Built-in Clock Battery Replacement

If the flashing **Low battery charge** icon appears on the display of the unit, you need to replace the built-in clock battery.

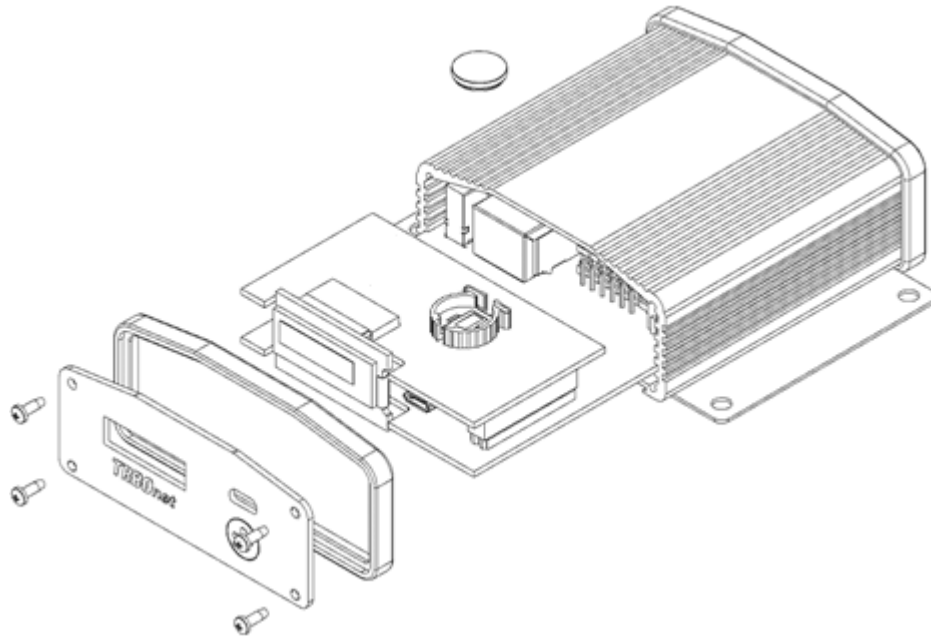

To replace the battery:

1. Disconnect the unit from the power supply. Disconnect all connectors on the rear panel.
2. Remove the screws and pull the front panel from the unit. Remove the seal.
3. Press the jacks on the rear panel to pull the board out of the unit.
4. Remove the old battery from the battery slot (Dispose of it according to local laws).
5. Insert a new CR1220 3V lithium coin battery so it matches the polarity: (+) to (+) and (-) to (-).
6. Insert the board inside the unit, assemble the seal and the front panel on the unit. Tighten the screws to secure the front panel to the unit.

Note: Use the recommended battery type. Batteries that look similar may differ in voltage.

6 Important Notes

- Disconnect TRBOnet Swift A200 from the power supply before connecting it to any external hardware.
- Power off the radio before connecting it to TRBOnet Swift A200 with the USB cable. When the radio is powered on, connecting or disconnecting the USB cable presents a high risk of damage to the USB interfaces of the radio and of TRBOnet Swift A200.
- Remember to update the firmware of TRBOnet Swift A200 and TRBOnet Swift ST002 (option board) before starting any operation.
- The manufacturer reserves the right to make changes and/or improvements in designs and dimensions without notice and without incurring obligation.

Appendix A: Service Cable Examples

A.1 Motorola CM 140 Two-Way Radio

The following diagram shows how to assemble the service cable for a Motorola CM140 two-way radio.

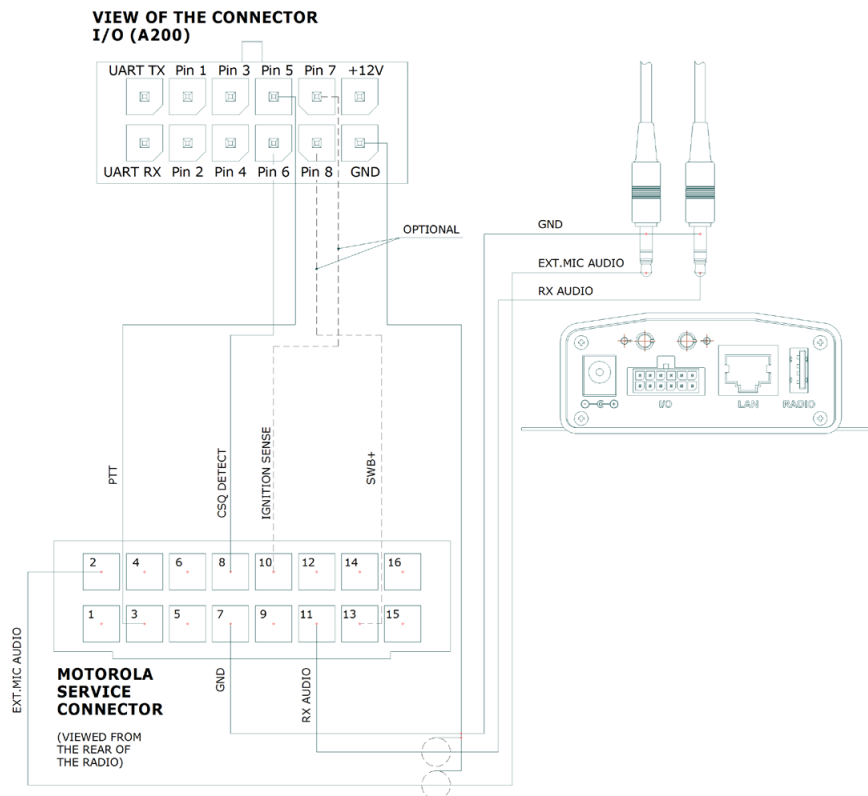

The following screenshot shows how to appropriately configure an CM140 radio in MOTOTRBO CPS:

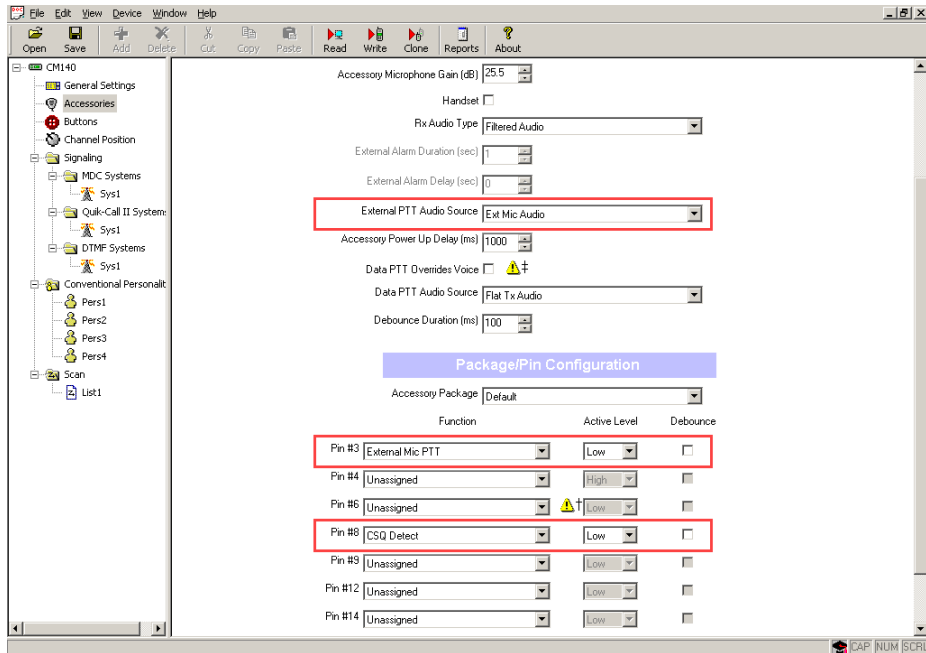

A.2 Motorola SLR 5500 Repeater

The following diagram shows how to assemble the service cable for a Motorola SLR 5500 repeater:

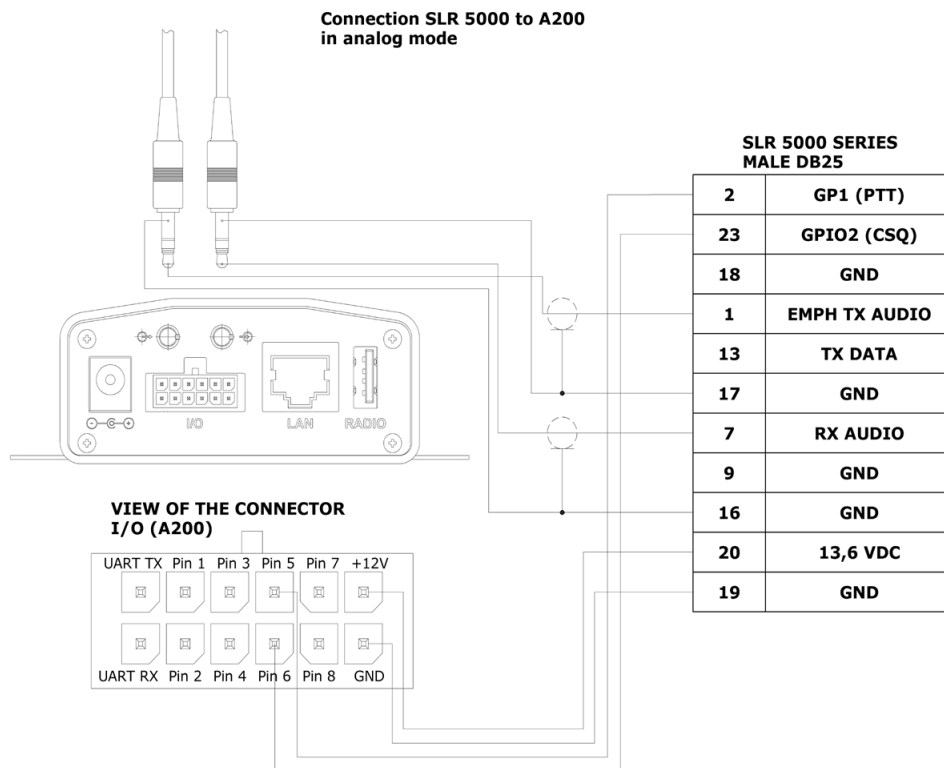

The following screenshot shows how to appropriately configure an SLR 5500 repeater in MOTOTRBO CPS:

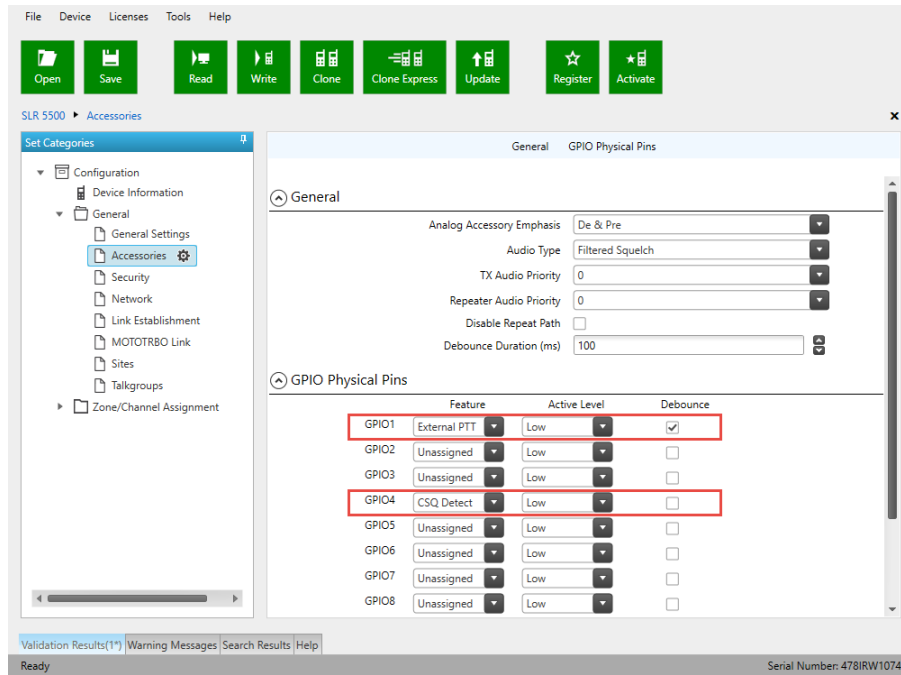

A.3 Tetra MTM5400/5500 Control Radio

The following diagram shows how to assemble the service cable for a Tetra MTM5400/5500 control radio:

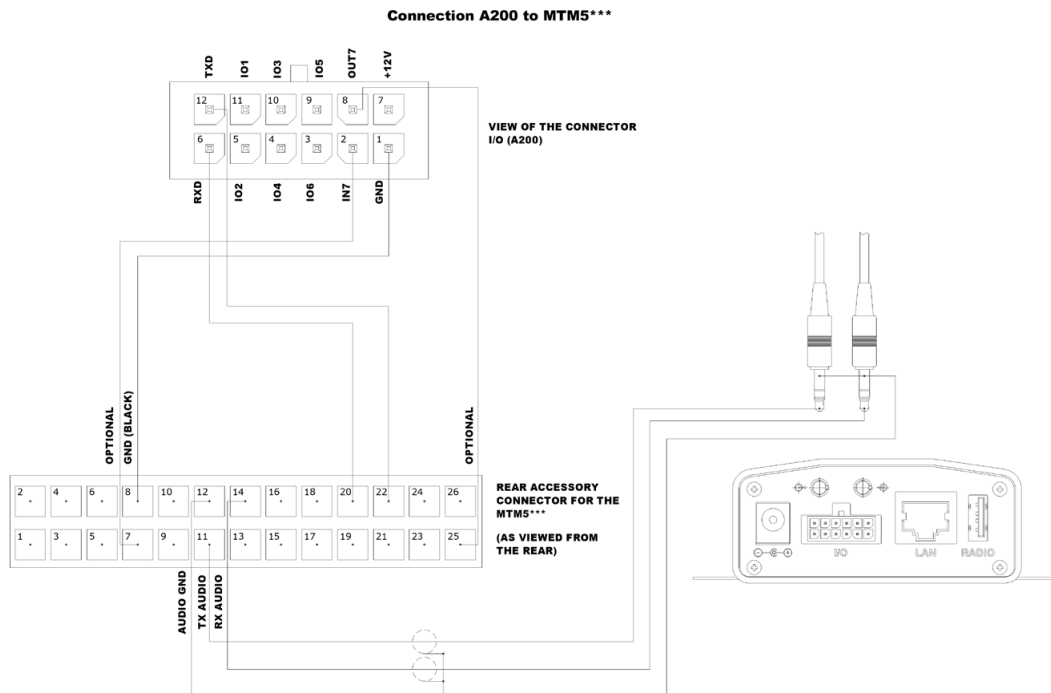

The following screenshots show how to appropriately configure an MTM5400/5500 control radio in Tetra CPS:

- **Control Head Configurations>Control Head Settings>Accessories Options**

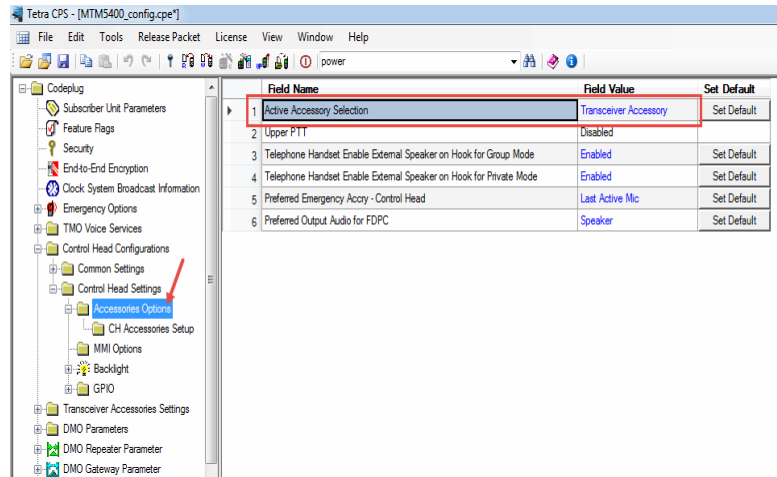

- **Transceiver Accessories Settings**

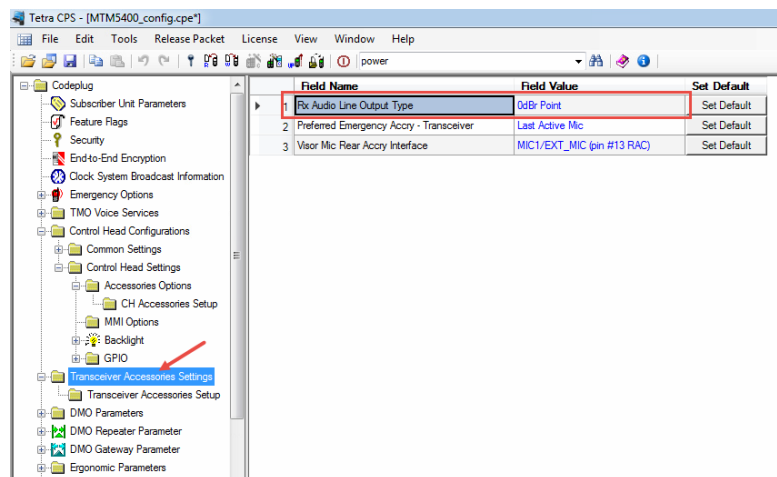

- **Transceiver Accessories Settings > Transceiver Accessories Setup**

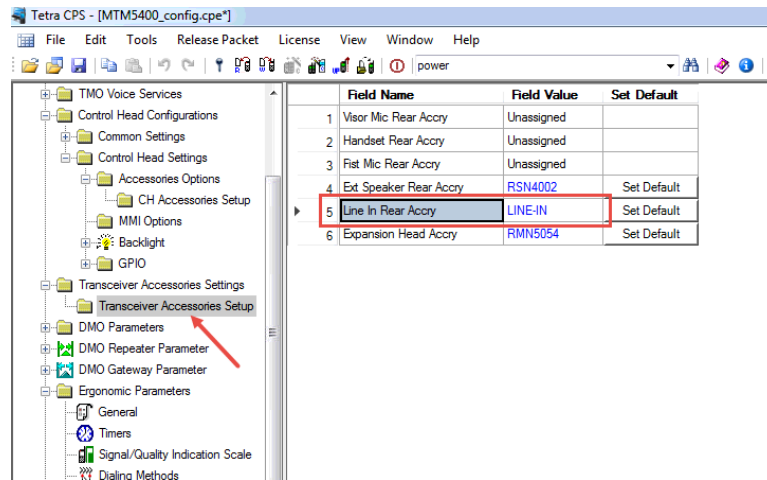

- **Audio Settings > Routing**

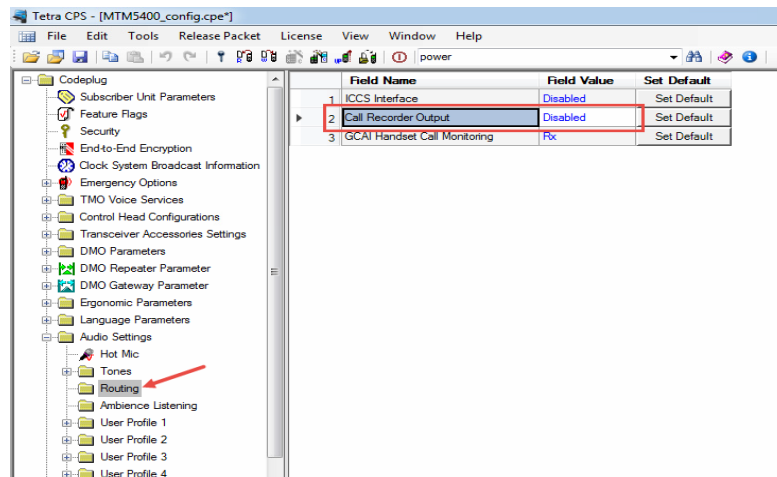

- **Ergonomic Parameters > Default Setting**

